

i-cover[®] 2.5

Rolling disinfectant sprayer

User manual



i-team Professional b.v.

Hoppenkuil 27b, 5626 DD Eindhoven, The Netherlands

Telephone: +31402662400

Email: hello@i-teamglobal.com

Internet: www.i-teamglobal.com





Original user manual, written in the English Language

Future Cleaning Technologies B.V.
Hoppenkuil 27b, 5626 DD Eindhoven, The Netherlands

Telephone: +31402662400

Email: hello@i-teamglobal.com

Internet: www.i-teamglobal.com

Model: I-COVER 2.5 24V

Date: 19/01/2021

Product code: IM25.FCT.1115B

Version: v.1.0



Preface

Thank you for purchasing the i-cover® 2.5 cold spray misting system. The i-cover 2.5 has an extraordinary disinfecting range of up to 375 m². To make things easy the i-cover 2.5 comes with an integrated backpack/trolley. You can carry the device by hand, shoulder, back or with the trolley. We have made disinfecting surfaces easy: just combine your favorite disinfectant (please read section 1.1 and 1.2 carefully) and our simple color coded spray nozzle system. Thanks to the 24 V Li-Ion batteries and exchangeable tanks, you can keep disinfecting all day long. The i-cover 2.5 is easy to use when you follow the instructions.

Please read this manual carefully for important information and operating instructions before using the i-cover 2.5. Save this manual for future reference. The manual is an essential part of the i-cover 2.5 and must be handed over to the new owner upon resale or exchange. This i-cover 2.5 will provide excellent performance. The best results will be obtained when the i-cover 2.5 is:

- regularly maintained per the i-cover 2.5 preventive maintenance instructions in this manual;
- operated with reasonable care and caution;
- maintained with manufacturer-supplied parts.

When this manual refers to “the manufacturer” this means: Future Cleaning Technologies B.V, an affiliate company of i-team in Eindhoven, the Netherlands. When this manual mentions “the partner” your local i-team resell and support service partner is referred to.

Purpose of the user manual

The purpose of the user manual is to provide the user with information in such a way that during the life of the i-cover 2.5 the machine is used correctly, efficiently and safely, even in the event of reasonably foreseeable misuse, as described in section 1.2 of this manual.

The user manual contains instructions regarding:

- personal operator safety;
- intended and non-intended use of the i-cover 2.5;
- instructions for daily use;
- maintenance instructions;
- storage conditions;
- disposal of the i-cover 2.5.

These instructions must be considered to avoid risks that could lead to physical and/or material damage.

Target audience

This user manual is intended for operators of the i-cover 2.5 and their supervisors, as well as partners and importers.







Operators of the i-cover 2.5

The i-cover 2.5 may only be operated by a person who has correctly read and understood the instructions in this manual or is trained by an experienced operator who has read and understood the instructions in this manual.



Reading guide

The following symbols and terms are used throughout this manual to alert the reader to safety issues and important information:

Symbol	Term	Explanation
	WARNING	Indicates a hazardous situation which, if the safety instructions are not followed, can lead to injuries of the operator or bystanders, light and/or moderate damage to the product or the environment.
	CAUTION	Indicates a hazardous situation which, if the safety instructions are not followed, can lead to light and / or moderate damage to the product or the environment.
	BATTERIES	Indicates a battery-operated machine, batteries must be charged according to the instructions in the separate Class I Battery Charger user manual. Batteries must be disposed of according to your local laws and regulations.
	ATTENTION	Indicates a liability situation, where the manufacturer or its partners and affiliates cannot be held accountable for damages caused by non-compliance.
	CORROSIVE	Can cause severe burns and damage to the eyes.
	PROTECTIVE EYEWEAR	Indicates protective eyewear is advised, for instance when filling the machine with cleaning solution.
	WASH HANDS	Indicates the operators are advised to wash their hands, for instance after filling and/or draining the cleaning solution.



Content

Preface	3
Purpose of the user manual	3
Target audience	3
Operators of the i-cover 2.5	3
Reading guide.....	4
Content	5
1 Introduction.....	7
1.1 Intended use of the product.....	8
1.2 Non-intended use of the product.....	9
1.3 Lifespan.....	9
1.4 Modifications.....	9
1.5 Specifications.....	10
1.6 Warranty.....	11
1.7 Identification	12
2 Description	13
2.1 Control panel	14
2.2 Control panel on the spay gun.....	14
2.3 Spray nozzles and nozzle filter.....	14
3 Safety.....	15
3.1 General safety instructions.....	15
3.2 Risks during operation	15
3.2.1 The disinfectant.....	15
3.2.2 The batteries	15
3.2.3 Personal protection.....	16
4 Transport and storage	17
5 Assembly and installation.....	18
5.1 Unboxing.....	18
5.2 Trolley or backpack operation	19
5.2.1 Trolley operation	19
5.2.2 Backpack operation.....	21
6 Operation	22
6.1 Before you start.....	22
6.1.1 Inserting the batteries.....	22
6.1.2 Filling the disinfectant tank	23
6.1.3 Attaching the right spray nozzle for the job.....	24



6.2	Trolley Operation.....	25
6.2.1	After operation.....	26
6.3	Backpack operation	27
6.3.1	After operation.....	29
6.3.2	Removing the spray nozzle.....	30
6.4	Cleaning and storage	30
6.4.1	Cleaning the body of the i-cover 2.5	30
6.4.2	Flushing the spray nozzle	30
6.4.3	Draining the machine	31
6.4.4	Cleaning with water	32
6.4.5	Removing the batteries	33
6.4.6	Storage	33
7	Maintenance	34
8	Troubleshooting	35
9	Decommissioning and disposal	36
10	Attachments	37
10.1	CE Certificate	37



1 Introduction

The i-cover® 2.5 is an easy and safe machine to use. This manual helps you get started and explains the operation and maintenance procedure.

The i-cover 2.5 is battery operated. The battery used in the i-cover 2.5 is the same as a variety of battery powered i-team products. The battery must be fully charged before use. A second battery is optional. Please refer to the user manual of the i-charge® 9 or the i-charge® 2 for the correct procedure.

This manual is intended for those who work with the i-cover 2.5 and perform daily maintenance. The manual must be read in full before the first actions. This manual describes the correct method of use, safety measures, maintenance and transport. And finally, the manual contains information about the consumables:

- the disinfectant;
- the color coded spray nozzles.

i-team continuously improves all their products based on user experience and feedback. Any deviations between the texts and/or images from the manual and your i-cover 2.5 can therefore arise from the difference in model or from possible changes due to continuous development and innovation.



1.1 Intended use of the product

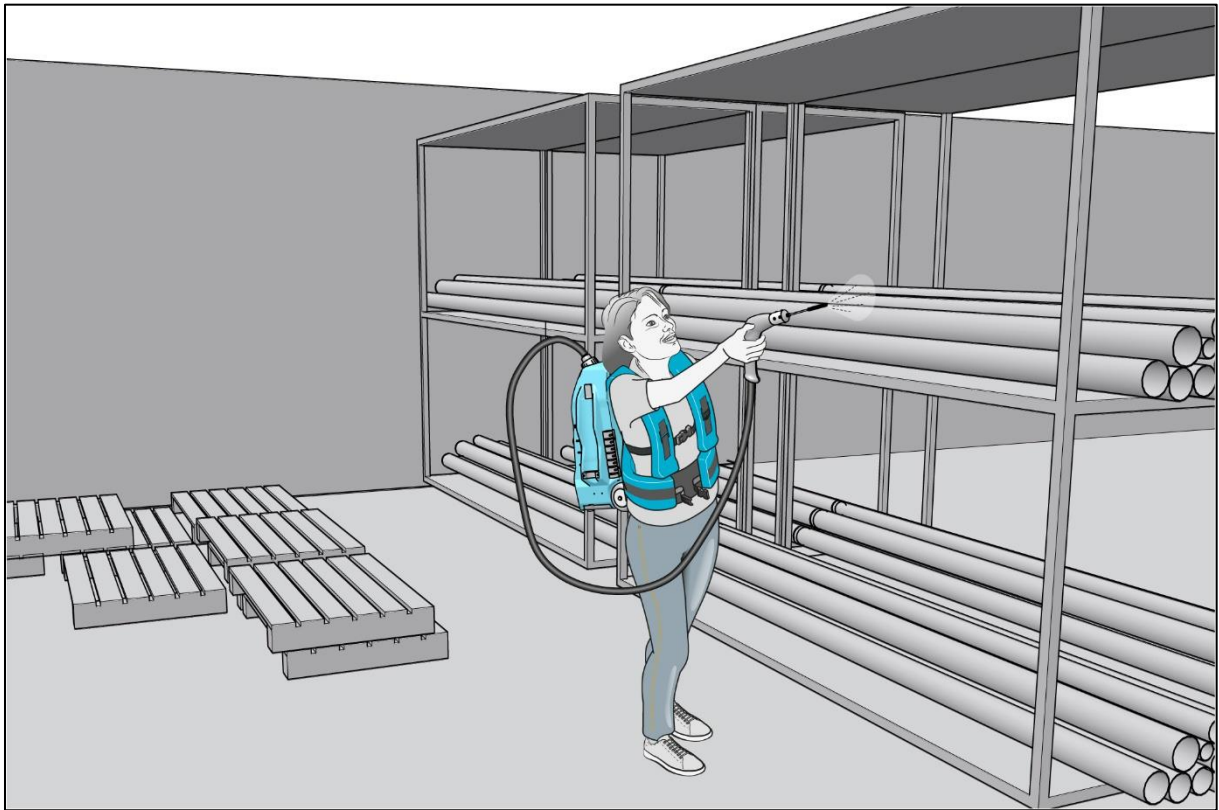

Figure 1

The i-cover® 2.5 is a specialized machine to disinfect surfaces only. You can hold the i-cover 2.5 in your hand using the handle, or hang it on your shoulder using the belt, see Figure 1.

In order to use the i-cover 2.5 for different applications, four sizes of spray nozzles are provided, each with their unique color code. These spray nozzles are easy to replace. Select the right spray nozzle for each job, see section 2.3.

Keep the spray nozzle away from your face as the disinfectant can blow out vapors that can cause irritation.

Always check the recommendations written on the packaging of the disinfectant that you use.

Use your favourite disinfectant solution at the appropriate dilution specified on the product label (if applicable). Disinfectants for which a dilution is needed that carries a corrosive pictogram (GHS05) or the hazard statements H290 “May be corrosive to metals”, or H314 “Causes severe skin burns and eye damage” should generally be avoided. Refer to the product’s in-use concentration SDS sheet.

Follow the recommended safety rules and guidelines as indicated by the manufacturer of your disinfectant.



1.2 Non-intended use of the product



WARNING

DO NOT fill the i-cover® 2.5 with disinfectants for which a dilution is needed that carries a corrosive pictogram (GHS05) or the hazard statements H290 “May be corrosive to metals”, or H314 “Causes severe skin burns and eye damage”. The use of these type of disinfectants should generally be avoided. Refer to the product’s in-use concentration SDS sheet. Alternative products will void the manufacturer’s warranty, more importantly they may also cause serious harm to the operator.



WARNING

Non-intended use can have consequences for the safety of operators and bystanders and will void the warranty on the product.

The i-cover 2.5 is not intended to disinfect anything else than surfaces.

1.3 Lifespan



CAUTION

To ensure proper and safe operation throughout the life of the i-cover, it is recommended to have an authorised i-team partner check the machine after the first 50 hours of use and then every 125 hours afterwards. To check the used operating hours, please check the hour meter on the main control panel. See section 2.1.

1.4 Modifications

It is not permitted to make modifications to the design of the i-cover 2.5 without consultation and permission from the manufacturer. This affects the warranty, refer to section 1.6 of this manual.



1.5 Specifications

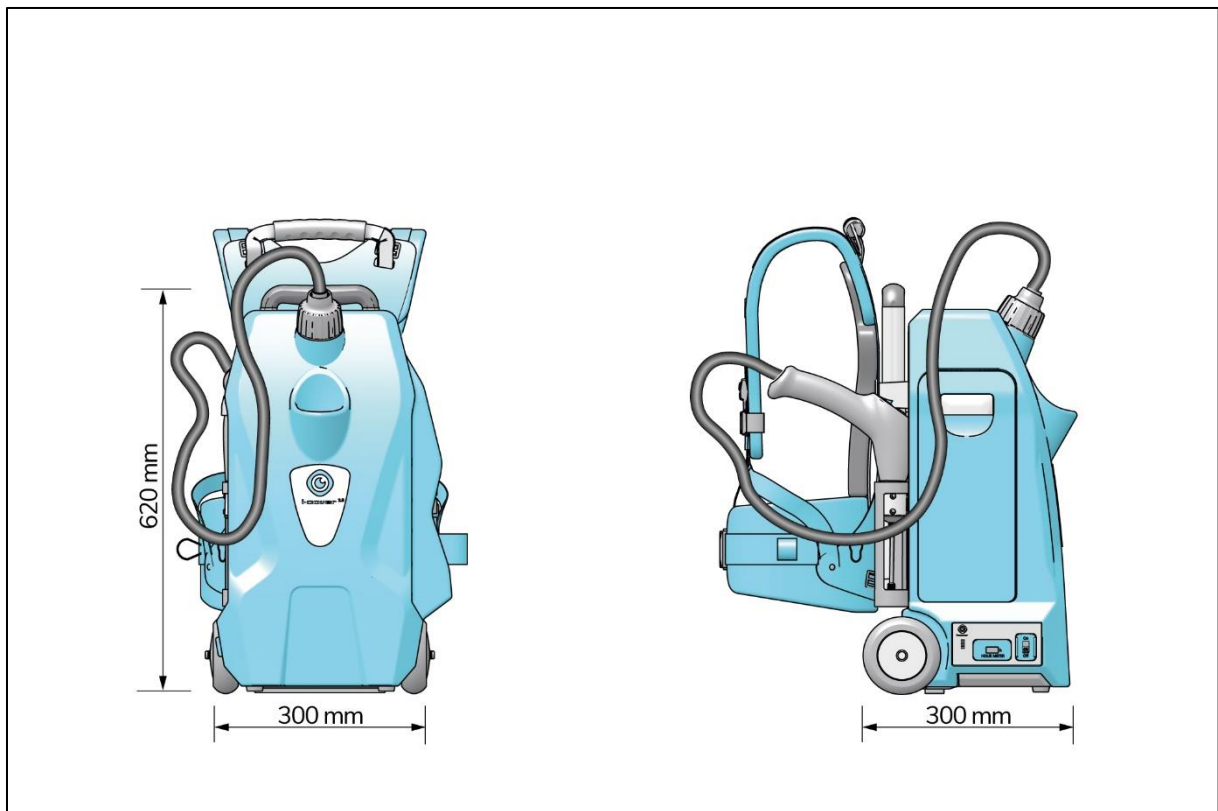

Figure 2

Body size (D x W x H):	300 x 300 x 620 mm
Total weight:	12 kg
Hose length:	144 cm
Extension tube length:	10 cm
Tank capacity:	2.5 l
Total work reach:	375 m ²
Application:	Surfaces
Power source:	i-power® 9 or 14 battery
Battery spec i-power 9:	24 V 8.8 Ah
Battery spec i-power 14:	25.2 V, 14 Ah
Run time i-power 9:	≈ 11 hours
Run time i-power 14:	≈ 18 hours
Material:	PP
Vibration (main body/handle):	Amplitude: 0.008 / 0.021 mm Velocity: 0.9/2.0 mm/s Acceleration: 0.7/0.7 m/s ²
Flow speeds:	0.2 mm spray nozzle: 25 ml/min 0.3 mm spray nozzle: 35 ml/min 0.5 mm spray nozzle: 70 ml/min 0.8 mm spray nozzle: 100 ml/min
Sound level (1 m distance and 1 m distance on 1.5 m height):	58.3 – 55.1 dB(A)



1.6 Warranty

The i-cover® 2.5 should only be operated with the materials supplied. Using alternative supplies may cause damage to the i-cover 2.5 and may cause a risk to the operator. The use of alternative supplies voids manufacturer's warranty.



1.7 Identification

Each i-cover® 2.5 has a unique identification number that can be found on the top of the main body. Your i-team dealer needs this number when you order parts.



Figure 3

Product type: i-cover 2.5

Serial number:

Current: 24 V/power 45 W

Distributor:
i-team Professional
Hoppenkuil 27 b
NL-5626 DD Eindhoven



2 Description

The compact lightweight i-cover® 2.5 consists of two main parts:

- the body, that contains the disinfectant tank, can be carried as a backpack or as trolley, or by hand;
- the spay gun with the spray nozzle.

The i-cover 2.5 consists of:

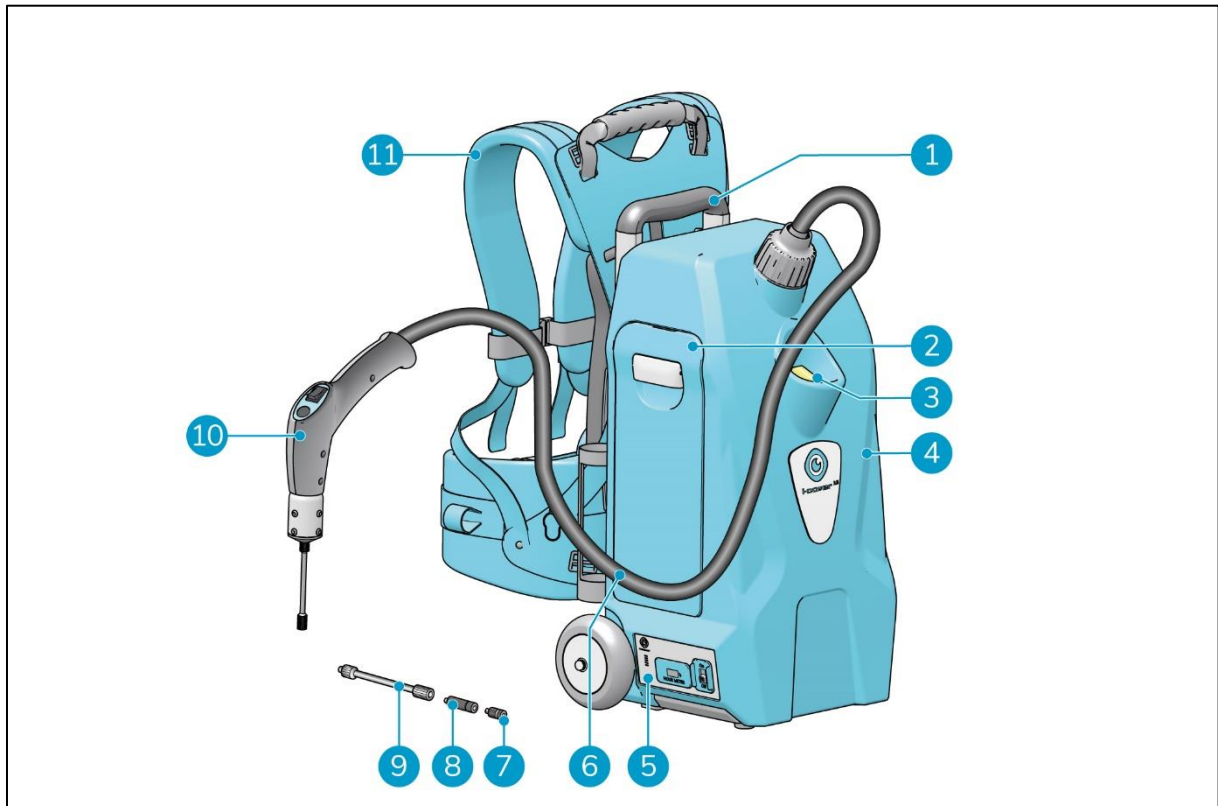

Figure 4

Legend

- | | |
|-------------------------|-----------------------|
| 1. A trolley. | 7. A spray nozzle. |
| 2. A battery hatch. | 8. A nozzle filter. |
| 3. A disinfectant tank. | 9. An extension tube. |
| 4. A main body. | 10. A spray gun. |
| 5. A control panel. | 11. A harness. |
| 6. A hose. | |



2.1 Control panel

1. Battery power status display. The green battery power status LEDs are on during normal use. When the battery is full all green LEDs are on, when the battery gets empty the green LEDs will go off one by one.
2. Hour meter. The counter on the right (Figure 5, pos B) counts in 6 minute cycles. This means that if the display shows a “1”, the i-cover® 2.5 has run for 6 minutes. After 10 cycles, the second counter from the right (Figure 5, pos A) will show a “1”, this indicates 1 hour. The counter on the right (Figure 5, pos B) starts again at “1”.
3. The ON/OFF switch.

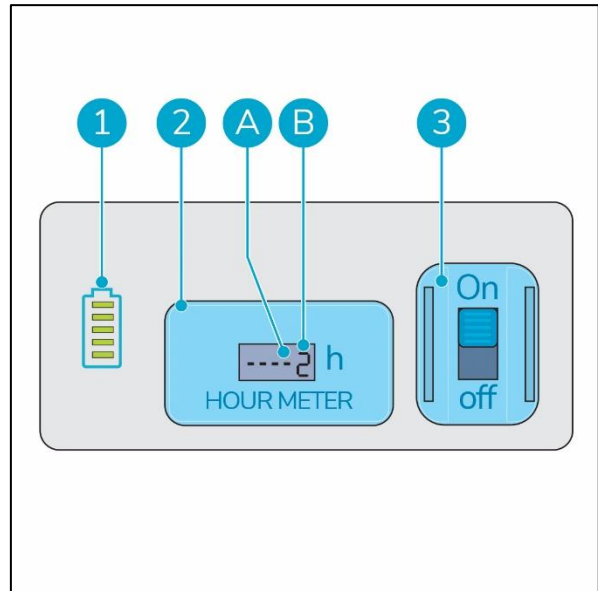

Figure 5

2.2 Control panel on the spray gun

1. The ON/OFF switch on the spray gun.

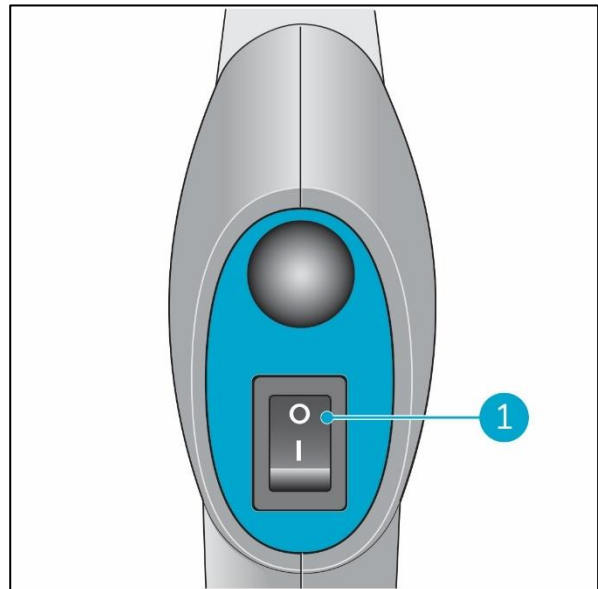

Figure 6

2.3 Spray nozzles and nozzle filter

Spray nozzle diameter and color	Intended spaces
0.2 mm x 1 yellow ring	Fragile or sensitive objects
0.3 mm x 1 green ring	Indoor applications
0.5 mm x 1 orange ring	Food preparation areas
0.8 mm x 1 blue ring	Outdoors and walls

If the nozzle becomes clogged due to a particular disinfectant, the nozzle filter can help to prevent clogging by attaching it in front of the spray nozzle.



3 Safety

Safety comes first. Therefore, please take your time to read and understand these safety instructions. Improper use can cause harm or void the manufacturer's warranty.

3.1 General safety instructions



WARNING

- always keep the body of the i-cover® 2.5 in an upright position when the disinfectant or the battery is inserted;
- always place the lance in the lance holder when work is interrupted.

3.2 Risks during operation

3.2.1 The disinfectant



WARNING

DO NOT fill the i-cover 2.5 with disinfectants for which a dilution is needed that carries a corrosive pictogram (GHS05) or the hazard statements H290 "May be corrosive to metals", or H314 "Causes severe skin burns and eye damage". The use of these type of disinfectants should generally be avoided. Refer to the product's in-use concentration SDS sheet.



WARNING

General safety rules:

- keep locked up and out of reach of children;
- keep away from food, drink and animal feed;
- when ingested, seek medical advice immediately and show the bottle. **DO NOT** induce vomiting.

3.2.2 The batteries



BATTERIES

During normal operation the 24 V batteries cause no safety hazard on their own. Please keep in mind the following safety instructions:

- do not crush, pierce or damage in any way;
- do not heat or incinerate;
- do not short-circuit;
- do not dismantle;
- keep the batteries dry;
- only charge between 5 °C ~ 40 °C / 41 °F ~ 104 °F;
- only use between 5 °C ~ 45 °C / 41 °F ~ 113 °F;
- only use the original batteries from the manufacturer.



3.2.3 Personal protection



ATTENTION

The disinfectant can be irritating to the eyes. Wear eye protection and use caution when filling. Always keep the spray nozzle pointed away from your face.



ATTENTION

Clean your hands immediately after filling or draining the disinfectant tank.



4 Transport and storage



CAUTION

Always keep the body of the i-cover® 2.5 in an upright position when disinfectant or batteries are inserted.

- before you transport the i-cover 2.5, remove the batteries. See section 6.3.1;
- before you store or transport the i-cover 2.5, it is recommended to drain it;
- store the steam lance in its holder during transport and storage;
- before you store the i-cover 2.5, it is recommended to clean the it with a damp cloth;
- do not store the i-cover 2.5 outdoors;
- store the i-cover 2.5 in an upright position and in a dry place;
- in case the i-cover 2.5 is stored for a longer period, remove the batteries. See section 6.3.1;



5 Assembly and installation

The i-cover® 2.5 does not require any assembly. A battery and a battery charger can be ordered separately.

5.1 Unboxing

The i-cover 2.5 is packed in 1 box.

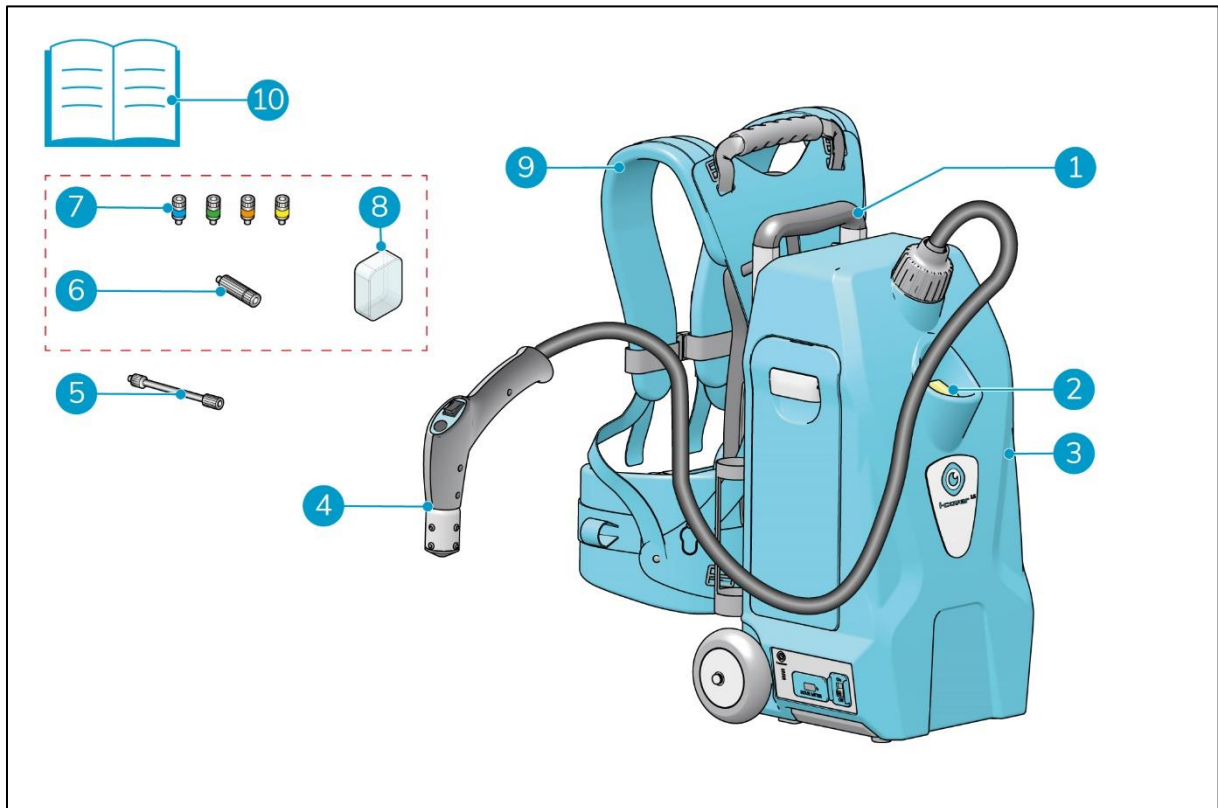

Figure 7

Legend

- | | |
|-----------------------------|---------------------|
| 1. 1x trolley | 6. 1x nozzle filter |
| 2. 1x disinfectant tank | 7. 4x spray nozzle |
| 3. 1x i-cover 2.5 main body | 8. 1x accessory box |
| 4. 1x hose with spray gun | 9. 1x harness |
| 5. 1x extension tube | 10. 1x this manual |



5.2 Trolley or backpack operation

5.2.1 Trolley operation

When you use the i-cover® 2.5 as a trolley it is advised to remove the harness so loose straps cannot be caught between the wheels. To remove the harness:

1. Remove the padding (Figure 8, pos 1) that is attached to the back plate with Velcro.

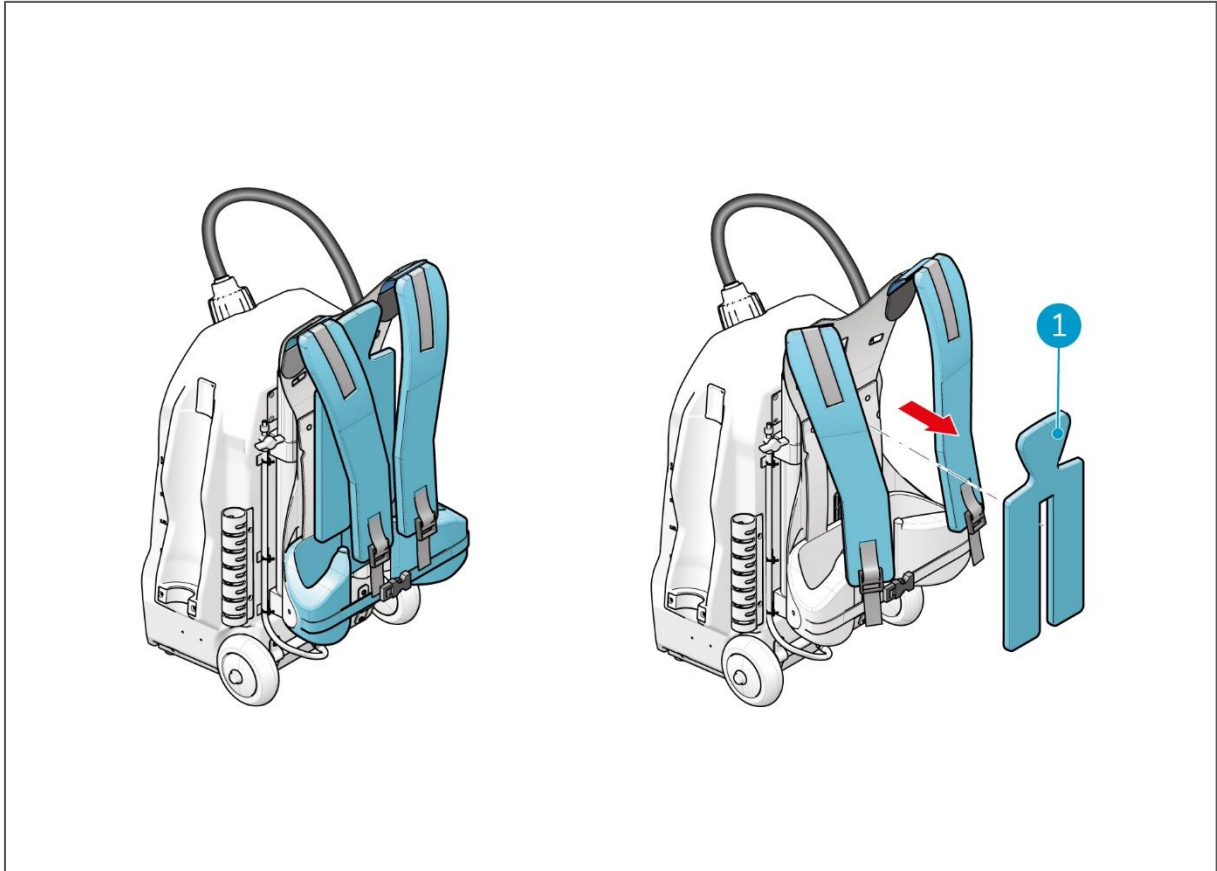

Figure 8



2. Unscrew the four screws (Figure 9, pos 2) using a Philips screwdriver.
3. Remove the back plate (Figure 9, pos 1).

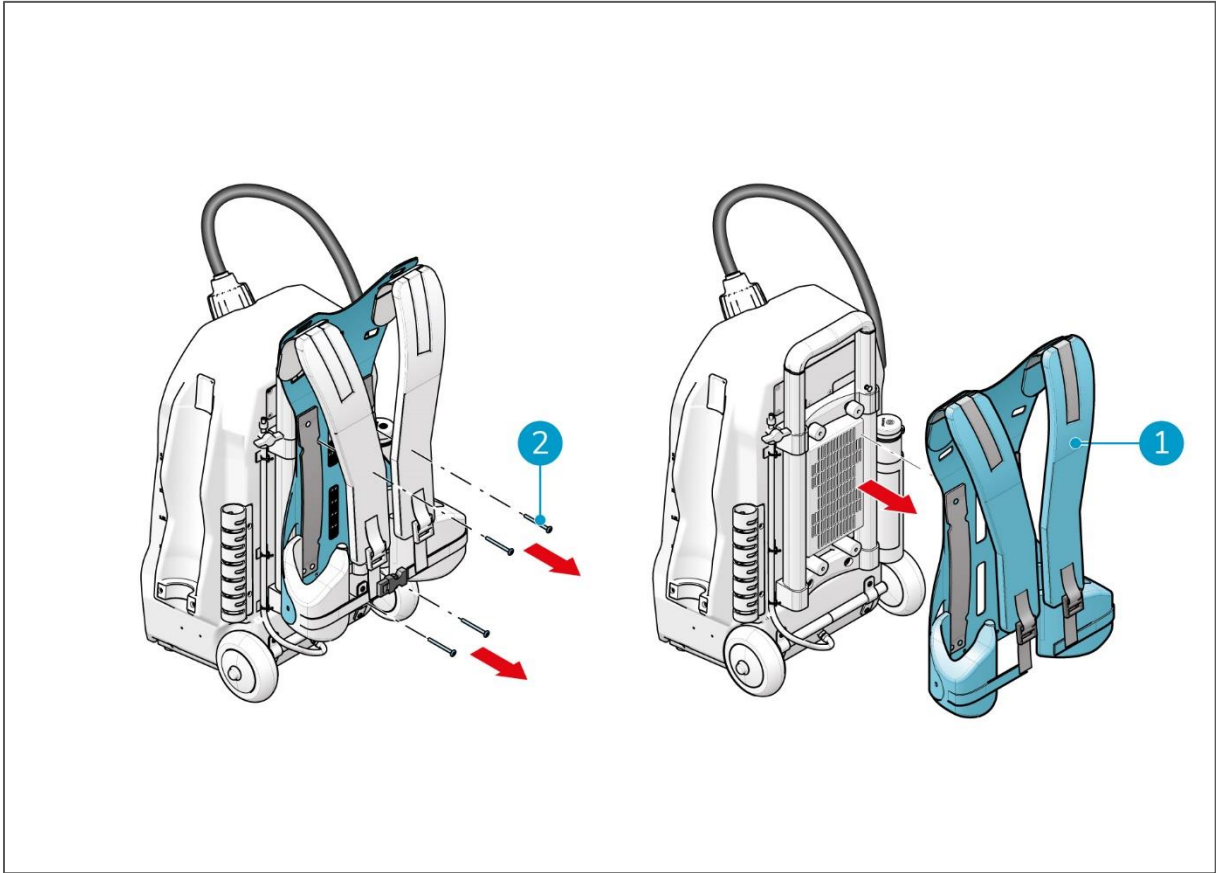

Figure 9



4. Put the four screws back in place, as these also hold the trolley handle (Figure 10, pos 1).

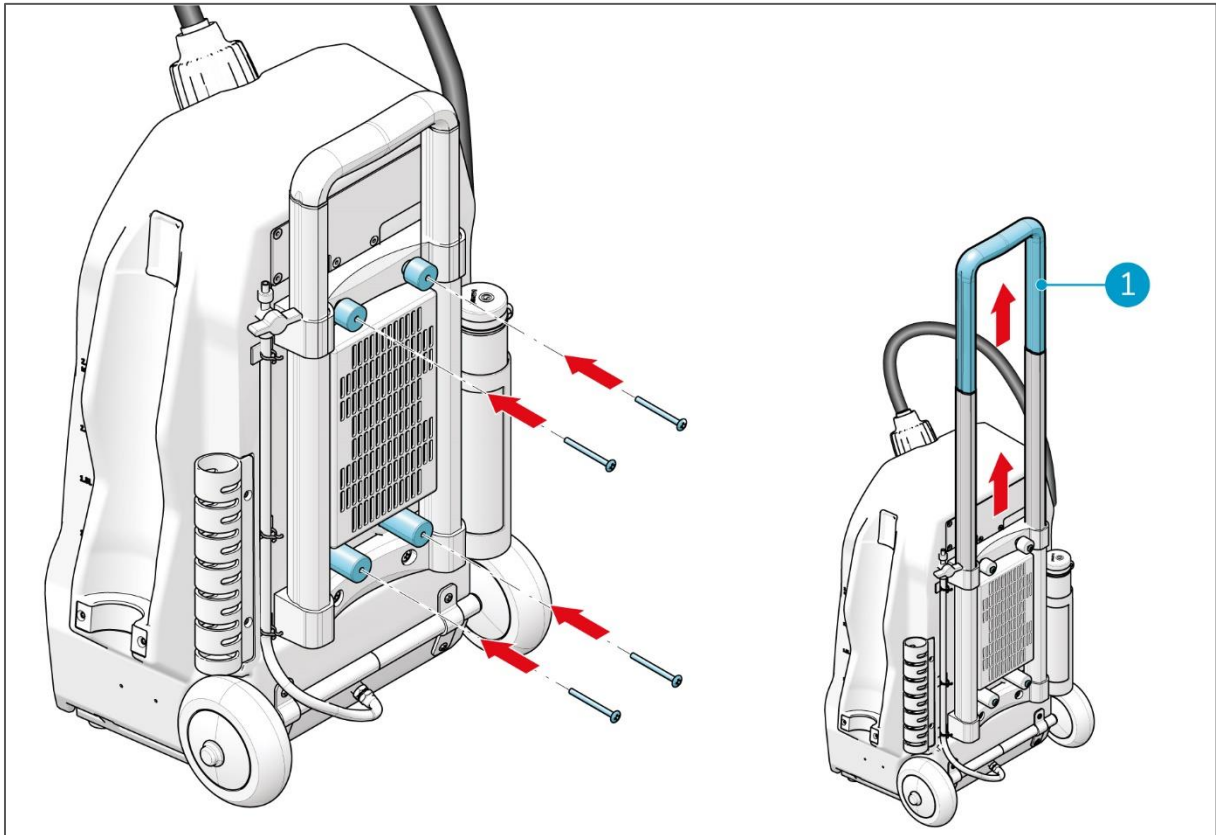

Figure 10

TIP:

Keep all removed parts safely stored for future use.

5.2.2 Backpack operation

When you use the i-cover® 2.5 as a backpack no further assembly is required.



6 Operation

6.1 Before you start



ATTENTION

- The i-cover® 2.5 can operate with only the blue coded battery, in this manual the optional gray battery is also described.
- Make sure that the batteries are fully charged before you start. Please refer to the user manual of the i-charge® 2 or the i-charge® 9.

6.1.1 Inserting the batteries

1. Open the battery holder (Figure 11, pos 2) at the side of the i-cover 2.5.
2. Place the blue coded battery in the blue battery slot at the top (Figure 11, pos 3).
3. Place the gray coded battery (option) in the gray battery slot at the bottom (Figure 11, pos 1).
4. Close the battery holder (Figure 11, pos 2).
5. Press the ON/OFF switch below the battery holder to turn on the i-cover 2.5.
6. Check the battery indicator next to the main switch. See also section 2.1.
7. Turn off the i-cover 2.5.

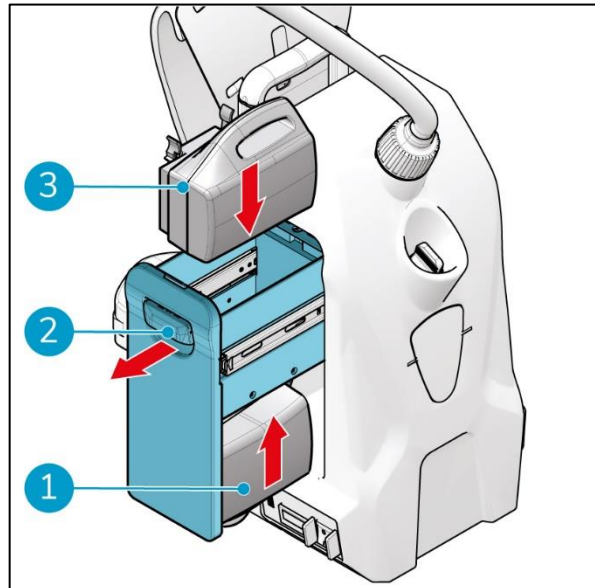

Figure 11

TIP:

It is not recommended to use the batteries when charged less than 40%. The i-cover 2.5 can operate on a single battery.



6.1.2 Filling the disinfectant tank

1. Remove the yellow stopper (Figure 12, pos 3).
2. Pour in the disinfectant (Figure 12, pos 2) while checking the fluid level (fig 12, pos 1).
3. Replace the yellow stopper (Figure 12, pos 3) and make sure it seals tight.
4. Clean your hands afterwards.

Dispose of empty bottles according to your local rules and regulations.

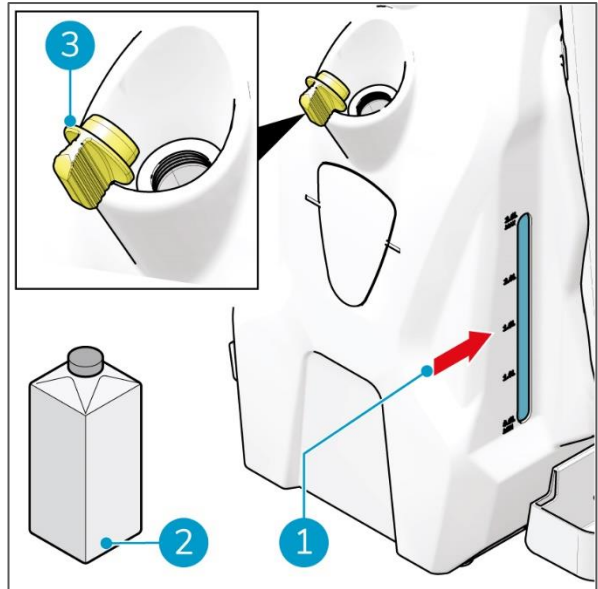

Figure 12



6.1.3 Attaching the right spray nozzle for the job

ATTENTION



- There are 4 different spray nozzles with each its specific application. Choose the right spray nozzle for the specific job. Please see section 2.3.
- All spray nozzles can be used in combination with the nozzle filter.

Normal use.

1. Turn the spray nozzle clockwise to attach it to the spray gun (Figure 13, pos 1).

Extended reach.

1. Turn the extension tube clockwise to attach it to the spray gun (Figure 13, pos 3).
2. Turn the spray nozzle clockwise (Figure 13, pos 2) to attach it to the extension tube.

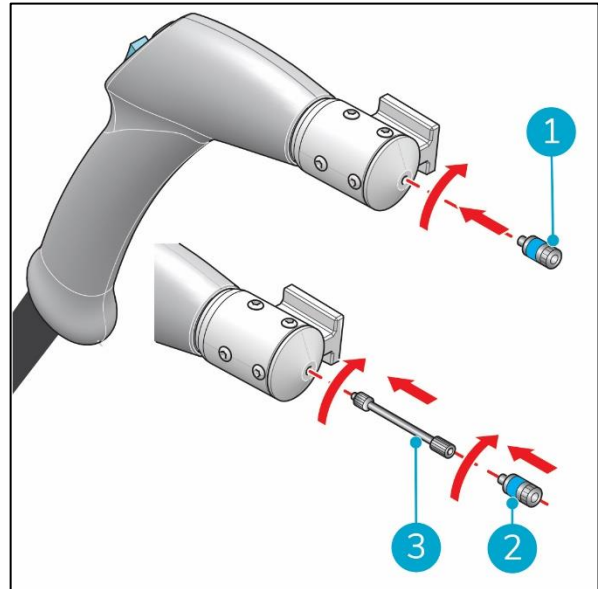

Figure 13



6.2 Trolley Operation

1. Walk to the location where you want to spray.
2. Press the ON/OFF switch (Figure 14, pos 1) to turn on the i-cover® 2.5. The hour meter and the battery power status display light up. See also section 2.1.
3. Press the ON/OFF switch on the spray gun (Figure 14, pos 2).
4. Start working with the i-cover 2.5.

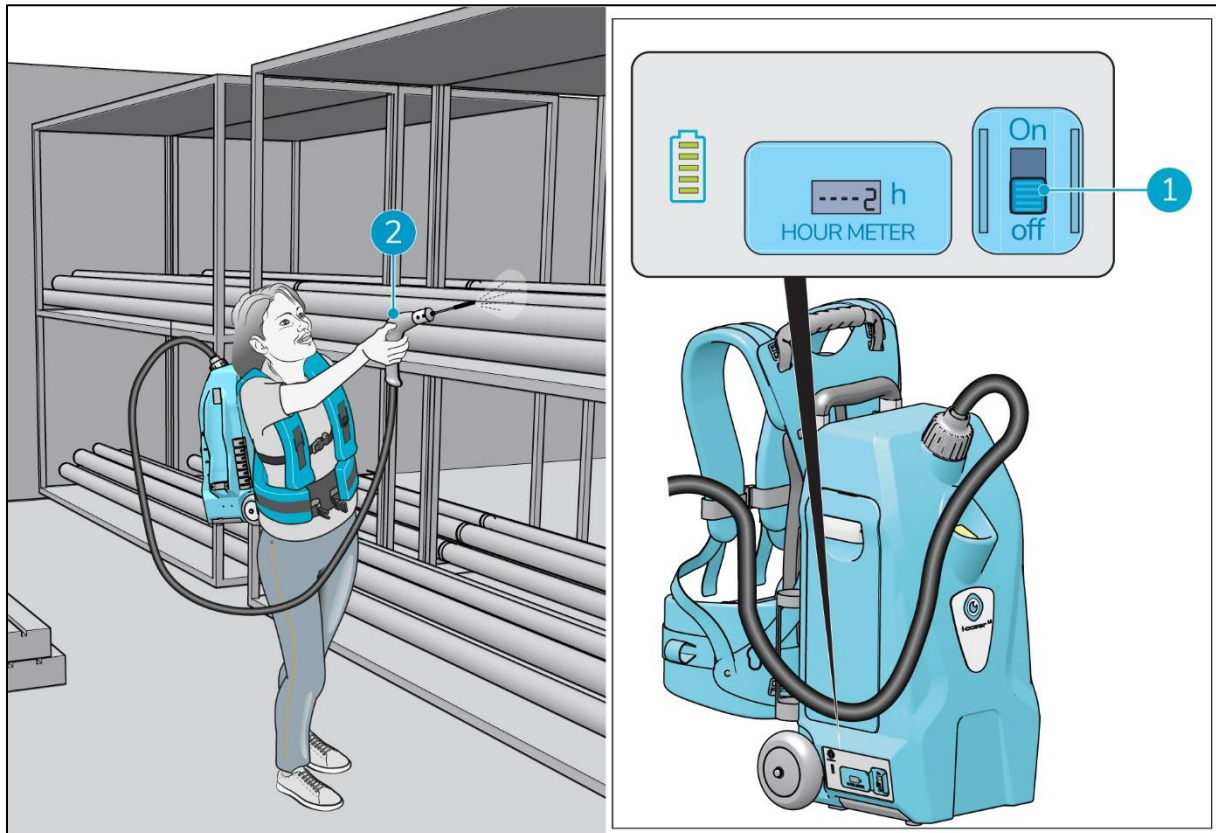

Figure 14



6.2.1 After operation

1. Press the ON/OFF switch on the spray gun (Figure 15, pos 1) to stop spraying.
2. Press the ON/OFF switch (Figure 15, pos 2) to turn off the i-cover® 2.5.

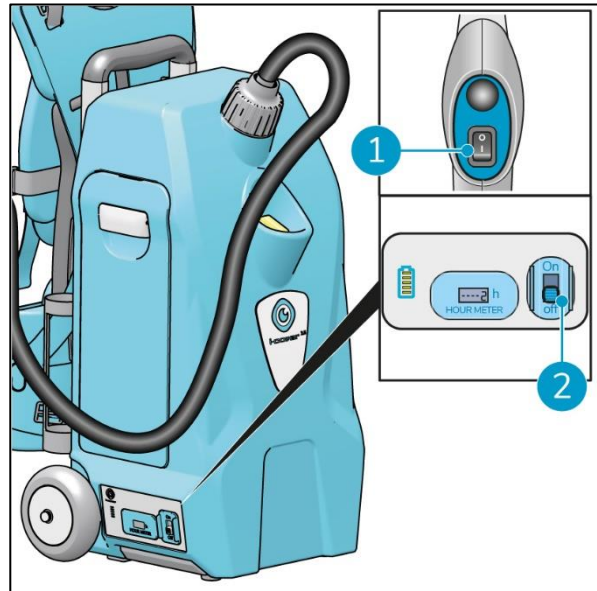

Figure 15

3. Open the battery holder (Figure 16, pos 2) at the side of the i-cover 2.5.
4. Remove the blue coded battery from the blue battery slot at the top (Figure 16, pos 3).
5. Remove the gray coded battery (option) from the gray battery slot at the bottom (Figure 16, pos 1).
6. Close the battery holder (Figure 16, pos 2).
7. Charge the batteries for next use, please refer to the user manual of the i-charge® 2 or i-charge® 9.

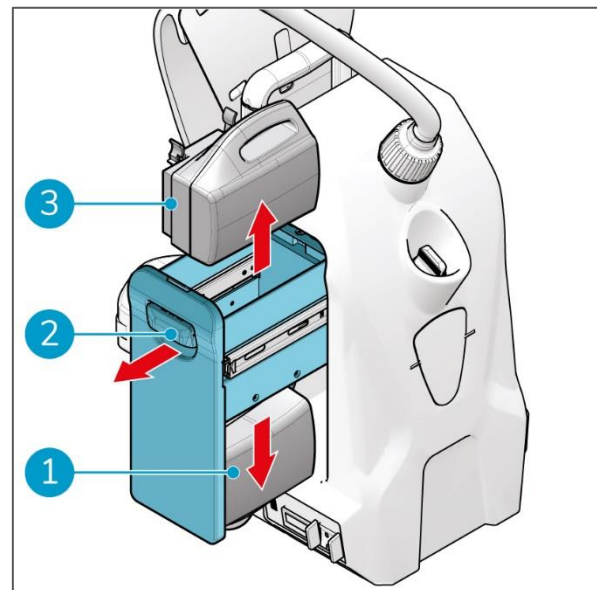

Figure 16



6.3 Backpack operation

1. Release the straps (Figure 17, pos 1) of the harness to their maximum size.
2. Remove the spray gun and place it on a chair or table.
3. Put on the backpack.
4. Adjust the waistband (Figure 17, pos 2) and the straps (Figure 17, pos 1) so they fit comfortably.

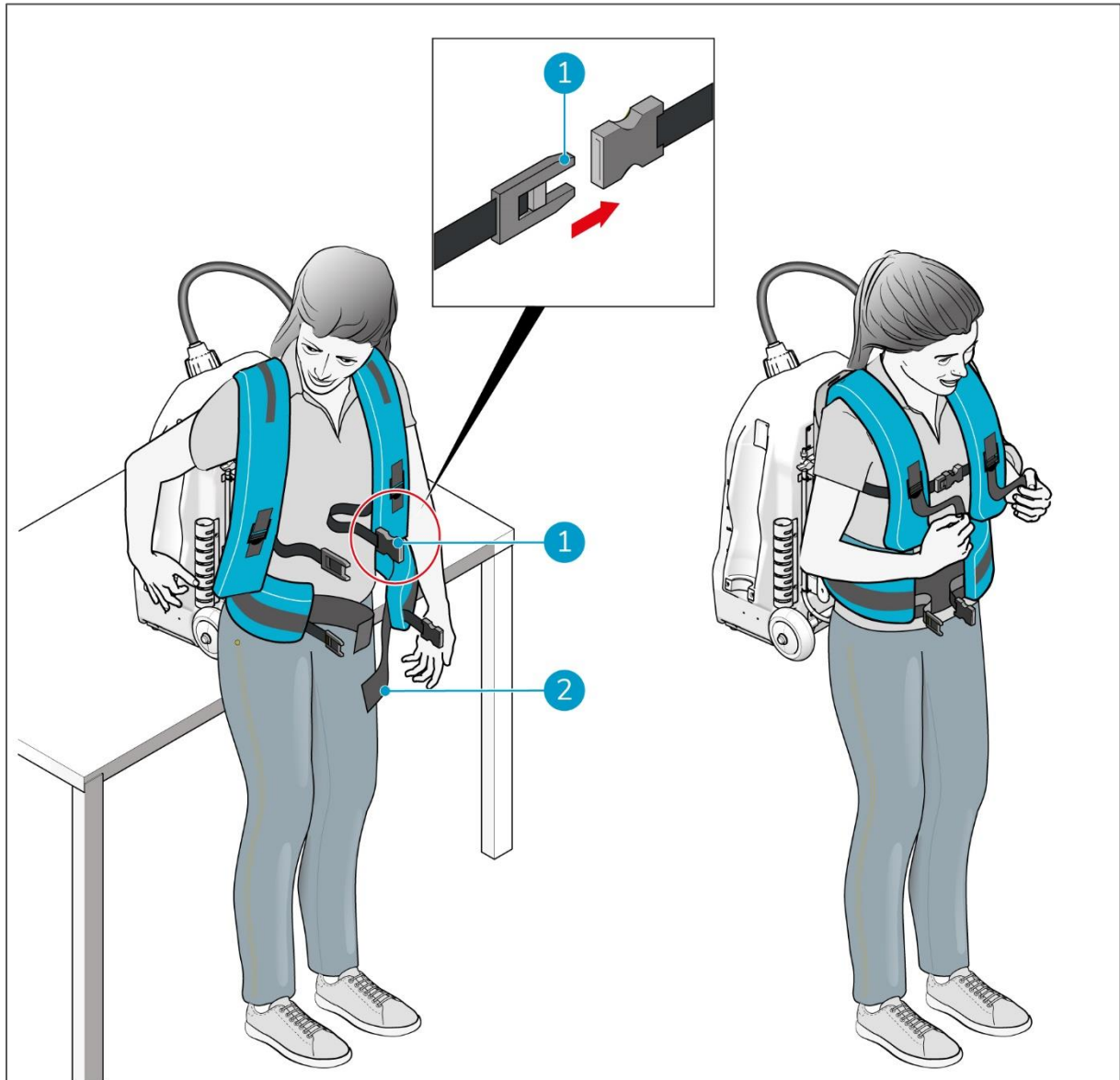

Figure 17



5. Walk to the location where you want to spray.
6. Press the ON/OFF switch (Figure 18, pos 1) to turn on the i-cover® 2.5. The hour meter and the battery power status display light up. See also section 2.1.
7. Press the ON/OFF switch on the spray gun (Figure 18, pos 2).
8. Start working with the i-cover 2.5.

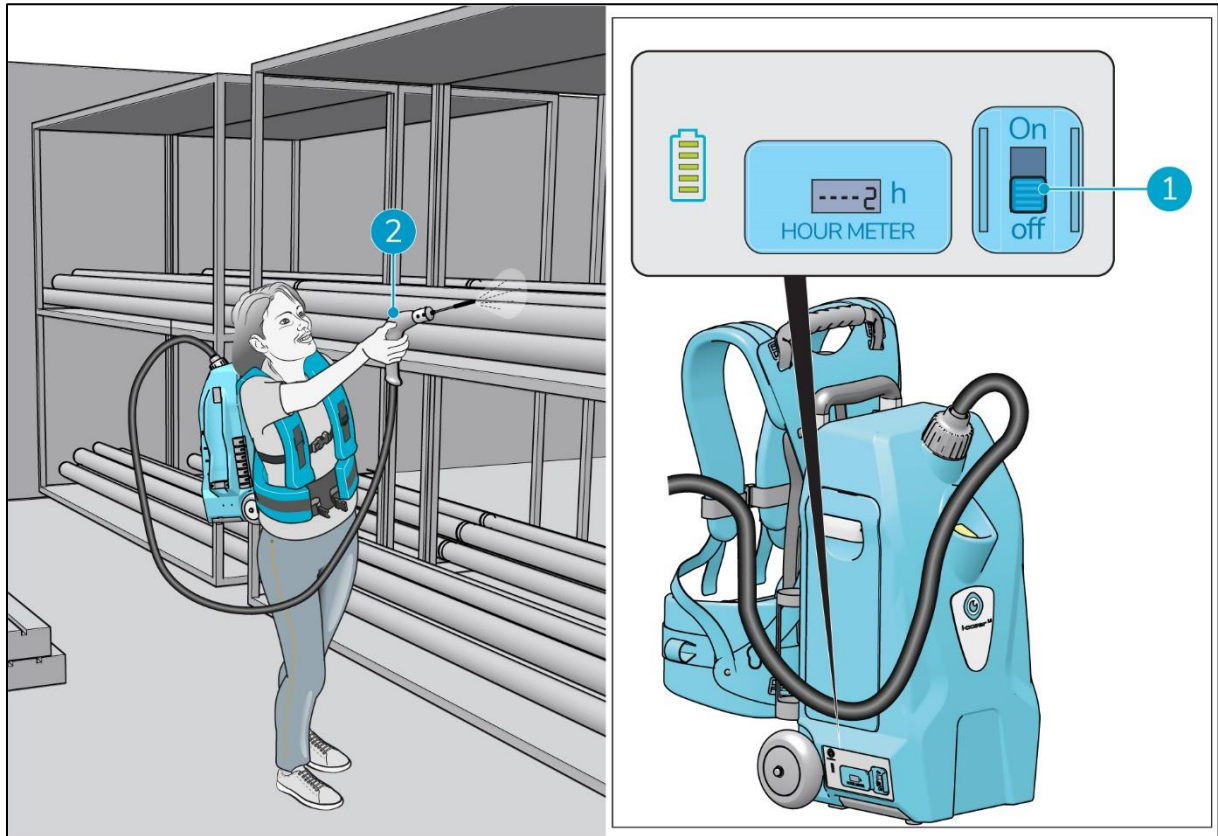

Figure 18



6.3.1 After operation

1. Press the ON/OFF switch on the spray gun (Figure 19, pos 1) to stop spraying.
2. Remove the backpack (see section 5.2.1) and close the strap (Figure 19, pos 2) to hold the waistband together.
3. Press the ON/OFF switch (Figure 19, pos 3) to turn off the i-cover® 2.5.

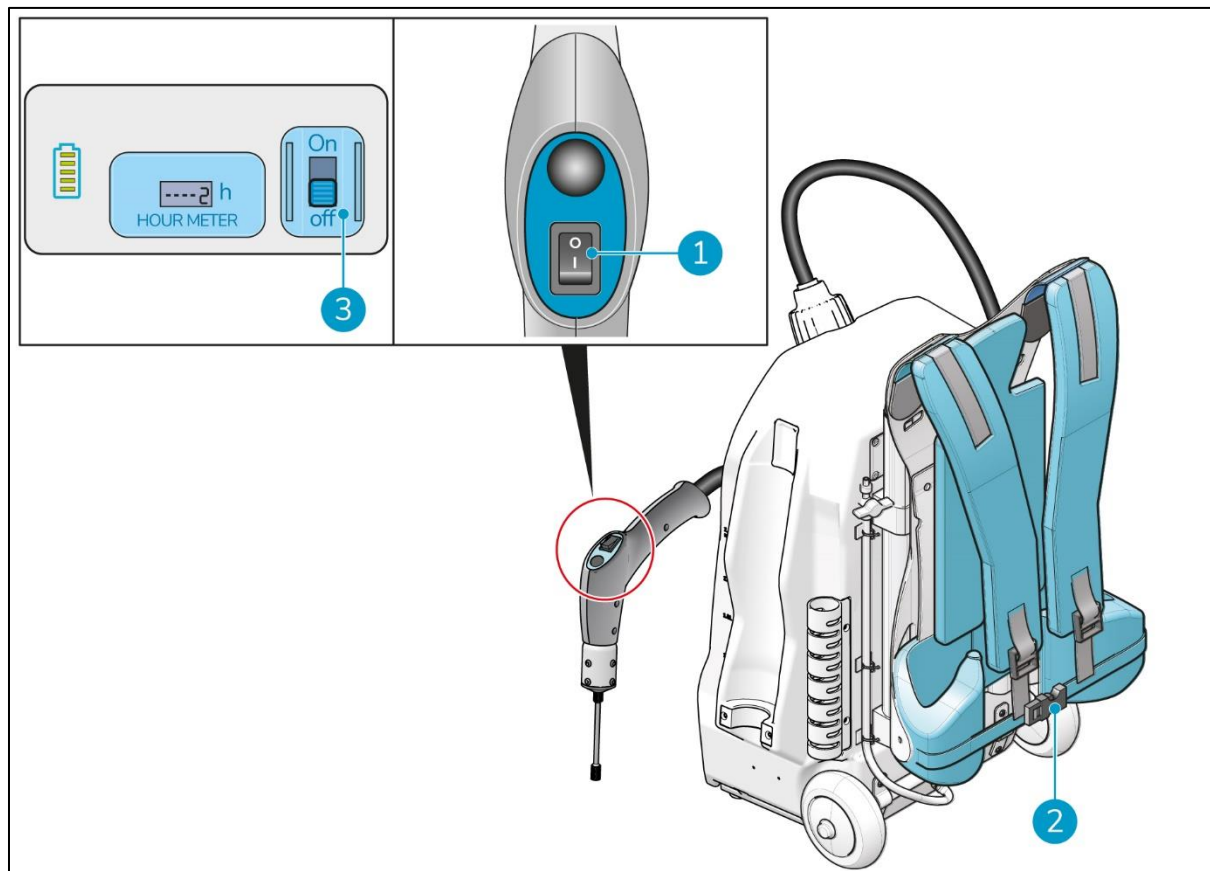

Figure 19

4. Open the battery holder (Figure 20, pos 2) at the side of the i-cover 2.5.
5. Remove the blue coded battery from the blue battery slot at the top (Figure 20, pos 3).
6. Remove the gray coded battery (option) from the gray battery slot at the bottom (Figure 20, pos 1).
7. Close the battery holder (Figure 20, pos 2).
8. Charge the batteries for next use, please refer to the user manual of the i-charge® 2 or i-charge® 9.

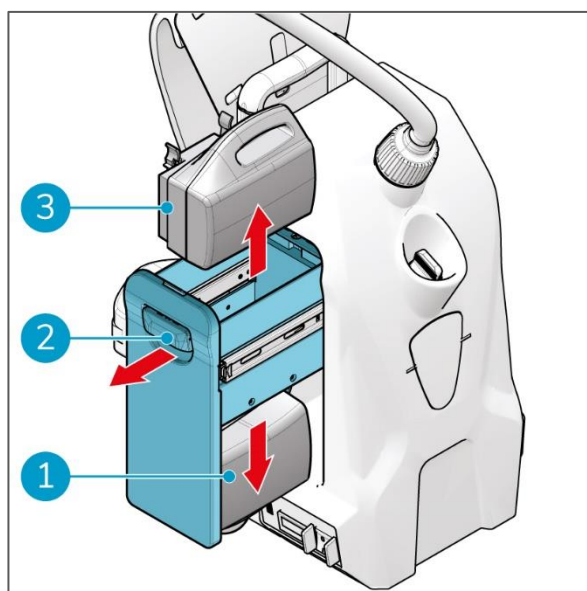

Figure 20



6.3.2 Removing the spray nozzle

You can remove the spray nozzle by following the procedure shown in section 6.1.3 in reversed order.

6.4 Cleaning and storage

WARNING



- **DO NOT** clean the i-cover® 2.5 with a high pressure cleaner;
- **DO NOT** submerge the i-cover 2.5 in water;
- turn off the i-cover 2.5 and remove the batteries.

6.4.1 Cleaning the body of the i-cover 2.5

Wipe the body of the i-cover 2.5 after each use.

6.4.2 Flushing the spray nozzle

To prevent blockage of the spray nozzle, it is recommended to flush the spray nozzle with tap water after each use. Or use an ultrasonic cleaner.

1. Remove the spray nozzle, see section 6.3.2.
2. Flush the spray nozzle (Figure 21, pos 1) with tap water.
3. Place the spray nozzle back in the spray gun or extension tube, see section 6.1.3.
4. Wipe the spray gun with a damp cloth.

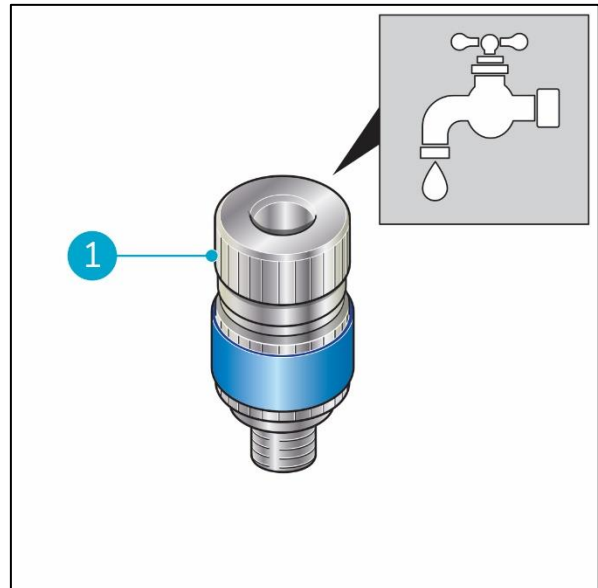

Figure 21



6.4.3 Draining the machine

1. Put the i-cover® 2.5 on a table with the backside towards you.
2. Release the drainage tube (Figure 22, pos 1) via the clips (Figure 22, pos 3).
3. Put the end of the drainage tube into a proper container for disinfectants.
4. Remove the yellow stopper from the fluid tank (Figure 12, pos 2).
5. Open the tap (Figure 22, pos 2).
6. When empty close the tap (Figure 22, pos 2).
7. Replace the yellow stopper (Figure 12, pos 2).
8. Replace the drainage tube (Figure 22, pos 1) using clips (Figure 22, pos 3).

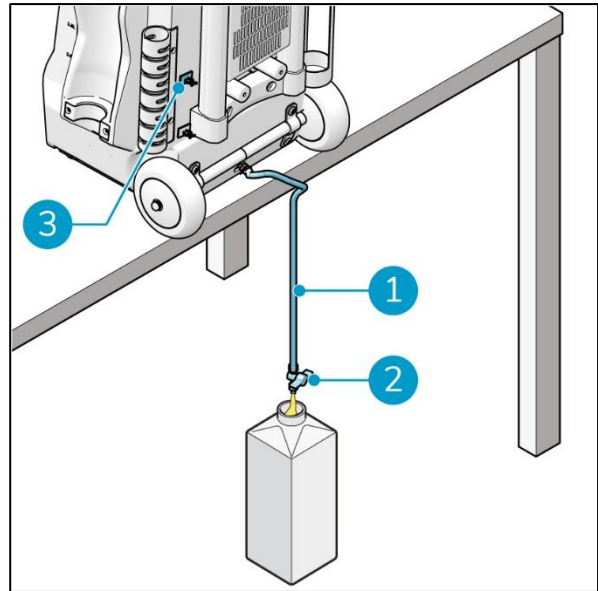

Figure 22



6.4.4 Cleaning with water



ATTENTION

Make sure the spray gun is facing away from you during this action.

1. Put the batteries in the machine (see 6.1.1).
2. Pour some water in the fluid tank (see 6.1.2).
3. Turn on the i-cover® 2.5 using the ON/OFF switch (Figure 19, pos 3).
4. Press the ON/OFF button (Figure 23, pos 2) on the spray gun.
5. Wait for 10-seconds, to allow some water to come out to clean the nozzle.
6. Press the ON/OFF button on the spray gun (Figure 23, pos 2).
7. Press the ON/OFF button on the body of i-cover 2.5 (Figure 19, pos 3) to turn it off.
8. Put the i-cover 2.5 on a table with the backside towards you.
9. Release the drainage tube (Figure 22, pos 1) via the clips (Figure 22, pos 3).
10. Open the tap (Figure 22, pos 2).
11. Put the end of the drainage tube into a proper container for disinfectants.
12. When empty close the tap (Figure 22, pos 2).
13. Replace the drainage tube (Figure 22, pos 1) using clips (Figure 22, pos 3).

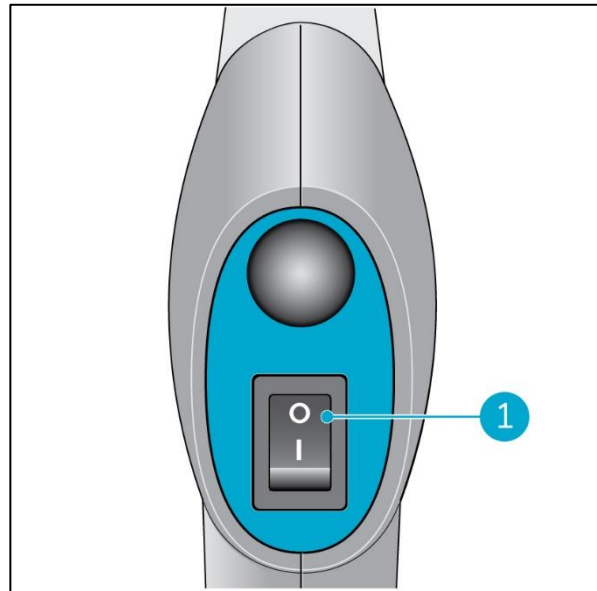

Figure 23



6.4.5 Removing the batteries

1. Open the battery holder (Figure 24, pos 2) at the side of the i-cover® 2.5.
2. Remove the blue coded battery from the blue battery slot at the top (Figure 24, pos 3).
3. Remove the gray coded battery (option) from the gray battery slot at the bottom (Figure 24, pos 1).
4. Close the battery holder (Figure 24, pos 2).
5. Charge the batteries for next use, please refer to the user manual of the i-charge® 2 or i-charge® 9.

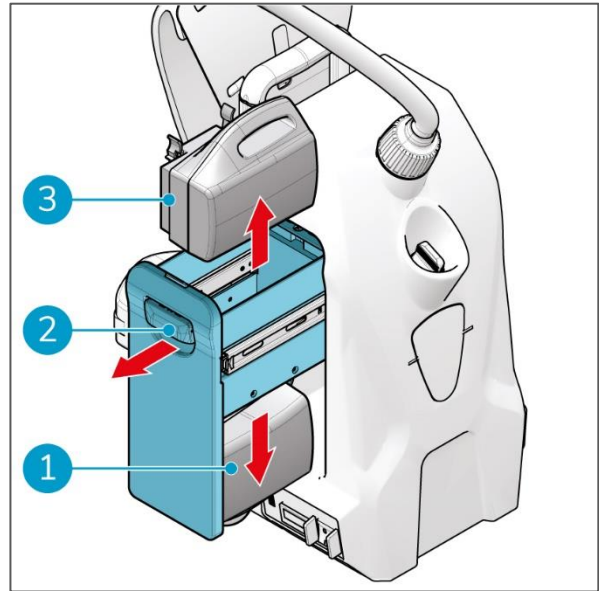

Figure 24

6.4.6 Storage

See section 4.



7 Maintenance

To ensure proper and safe operation throughout the life of the i-cover® 2.5, it is recommended to have an authorized i-team partner check the machine after the first 50 hours of use and then every 125 hours afterwards.



8 Troubleshooting

Problem	Cause	Solution
i-cover® 2.5 does not work	ON/OFF switch and/or switch on the spray gun are turned off	Turn on the ON/OFF switch and/or switch on the spray gun.
	Empty battery*	Charge the battery*.
	Battery* not correctly inserted	Make sure to reinsert the battery* correctly, until you hear a click.
Fluid leakage	Filler cap is not put back correctly	Check and replace the filler cap correctly.
	Drain connector cap is not put back correctly	Check and replace the drain connector cap correctly.
	i-cover 2.5 was stored or transported lying down without draining the tank first	Place the i-cover 2.5 upright.
Battery* not charging	Battery* is end of life	Replace battery*.

* Or batteries in case two batteries are used.



9 Decommissioning and disposal



ATTENTION

It is the responsibility of the i-cover® 2.5 owner to dispose of the product responsibly.

At the end-of-life the i-cover 2.5 still contains valuable resources and needs to be disposed of according to your local laws and regulations regarding recycling of electrical equipment.



Before disposal please:

1. Remove the batteries for separate disposal.

TIP:

Alternatively, keep the batteries for use in another piece of i-team equipment.

2. Empty the disinfectant tank.
3. Remove all loose components, like spray nozzles, the belt and carrying handle.
4. Dispose all items according to your local laws and regulations.

TIP:

Contact your local i-team partner to explore all possibilities of returning components at the end-of-life of your i-cover 2.5.



10 Attachments

10.1 CE Certificate



EG/EC
KONFORMITÄTSERKLÄRUNG
DECLARATION OF CONFORMITY

Wir:

We: Future Cleaning Technologies B.V., Hoppenkuil 27b, 5626 DD Eindhoven, Netherlands

Erklären in alleiniger Verantwortung, das das Produkt: Nebelgerät
Declare under our sole responsibility that the product: Fogger

I-COVER

(Art der Maschine / Type of machine)

I-COVER 1.0 & I-COVER 2.5
und folgende / and following

(Modell – Seriennummer, Baujahr / Model – serial number, year of production)

auf das sich diese Erklärung bezieht, mit den folgenden Normen übereinstimmt, to which this declaration relates is in conformity with the following standards,

EN 55014-1:2017, EN 55014-2:2015, EN 60335-1:2012+A13:2017, EN 60335-2-68:2012, EN 62233:2008

(Titel und/oder Nummer sowie Aufgabedatum der Norm(en) oder der anderen normativen Dokument(e)
(Title and/or number and data of issue of the standard(s) or other normative document(s))

gemäss die Bestimmungen der Richtlinien: follow the provision of directives:

EMC 2014/30/EU, Machinery 2006/42/EU, ROHS 2011/65/EU, EU 2015/836 Annex II

Eindhoven, 30.04.2020

Frank van de Ven
Director

(Ort und Datum der Ausstellung)

(Place and Date of issue)

(Name und Unterschrift oder gleichwertige
Kennzeichnung des Befugten)

(name and signature or equivalent marking or
authorized person)



This document is part of the technical file of the i-cover® 2.5 and will be available upon request.